

SPICE thermal model

BUK7Y18-55B

Symbol	Parameter	Conditions	Min	Typ	Max	Unit
$R_{th(j-mb)}$	thermal resistance from junction to mounting base		-	-	1.8	K/W

C_{th1}	2.589E-02 F
C_{th2}	4.042E-03 F
C_{th3}	9.598E-04 F
C_{th4}	2.279E-04 F
C_{th5}	5.413E-05 F
C_{th6}	1.285E-05 F
C_{th7}	3.053E-06 F
C_{th8}	7.249E-07 F
R_{th1}	1.159E+00 Ω
R_{th2}	4.498E-01 Ω
R_{th3}	1.148E-01 Ω
R_{th4}	2.929E-02 Ω
R_{th5}	7.473E-03 Ω
R_{th6}	1.907E-03 Ω
R_{th7}	4.865E-04 Ω
R_{th8}	1.241E-04 Ω

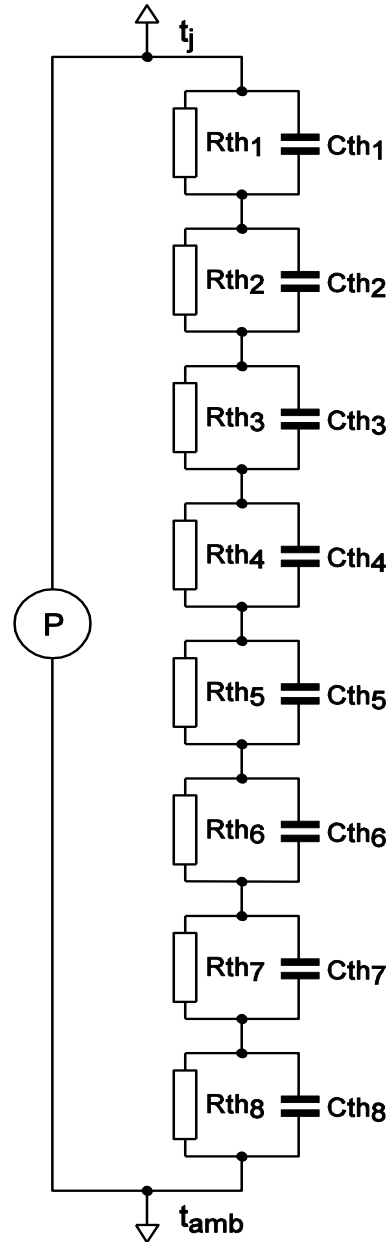

001aal768

Part: BUK7Y18-55B
 Version: 1
 Date: 23-3-2010
 Rth: 1.8